

SURROUND YOURSELF with SAFETY

TECHNICAL DOCUMENTATION



SENSITIVE EDGES

The sensitive edge is a safety component to avoid crashing or cutting risks by sliding doors, automatic moving protections, electrical gates etc. The edges feature a PVC or EPDM coating, inside is a sensor (2 conductive blades, separated by a

non-conductive part). When the edge is pressed, the blades are in contact and close the circuit. The state change of the internal sensor (NO to NC) is processed by the control unit that sends a machine stop signal, eliminating the danger situation.

TYPES OF EDGES

Type B0
Type B1N
Type B2
Type B2N

Standard solution: length upon customer's request with pre-assembled sensor and aluminium support

Conductive edge type B1NC 8,2kΩ
Conductive edge type B1NC-AG B1NC-AGB 8,2kΩ
Conductive edge type B2C 8,2kΩ
Conductive edge type B2C-AG B2C-AGB 8,2kΩ
Conductive edge type B0C B0C-AG 8,2kΩ

Standard solution (upon request) or "do it yourself" (cutting/assembly of accessories by customer/installer)

Edge type "B0"

Profile of black EPDM. The edges feature a sensor on the upper part of the profile to get maximum sensitivity.

Particularly suitable for safety catches or as an alternative to emergency wire micro switching. Supplied with both sides adhesive tape for wall fixing.

The edges of the profile are sealed with polyurethane resin to perfect watertight.

The outlet cable can be only on head side.

Edge type "B1N" - "B2" - "B2N"

Profile of black PVC for B1N and B2N; material EPDM for type B2. The edges feature a sensor on the bottom of the profile, to get a sensibility with front side operations, as well as with a max. angle of $\pm 45^\circ$. The ends of the profile are closed using polyurethane resin (better tightness). Particularly suitable for bent edges.

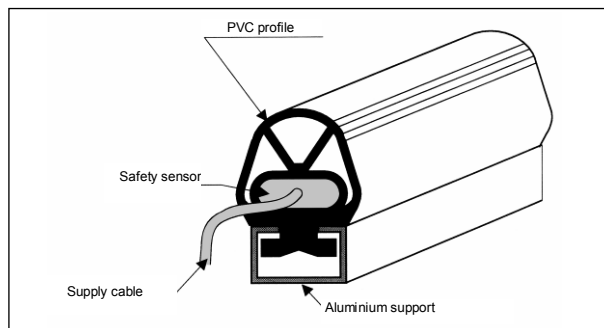

The supply cable is a 4 poles cable 4*0,35mm² FROR 300/500 standard length 3 meters. Different lengths can be supplied upon request.

For the B1N-B2-B2N the standard outlet of the cable is at the end of the profile.(Head outlet)
Upon request, the cable outlet can be on the bottom, right or left side (see drawing).

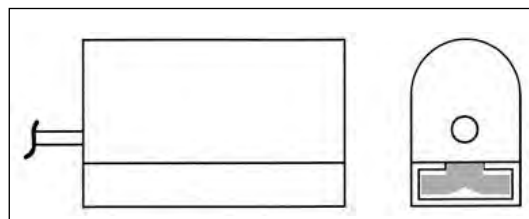

Head outlet (standard)

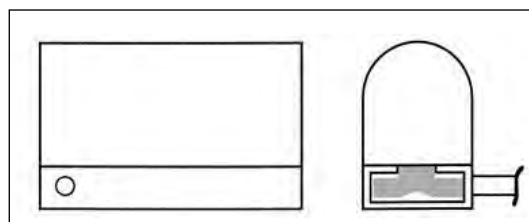

Side outlet right(see picture) or left

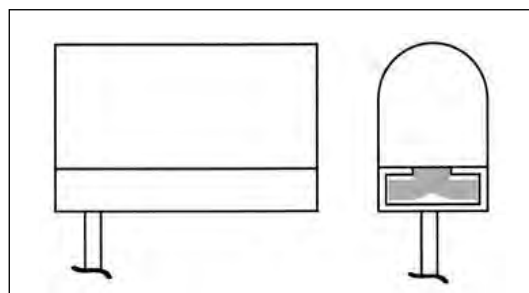

Bottom outlet

TECHNICAL FEATURES

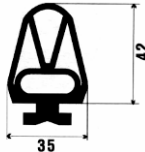
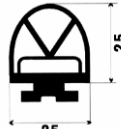
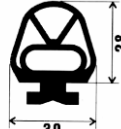
Description	Type B0	Type B1N	Type B2	Type B2N
				
Operating distance	3 mm	5 mm	5 mm	5 mm
Overrun operation	2 mm	20 mm	8 mm	10 mm
Operating thrust	30N	30N	30N	10N
Material	EPDM	PVC	EPDM	PVC
Length	max15 m upon request	max 6 m upon request		
Fastening material	Double-sided adhesive tape	Alu profile		
Chemical resistance	Acids, atmospheric agents	Oils, hydrocarbons, Diesel oil	Acids, atmospheric agents	Oil, hydrocarbons, Diesel oil
Degree of protection	IP54			
Operating temperature	-5°C to +50°C			
Power cord	2*0.35mm			
Output contact	NO			
Max contact voltage	30 V			
Max contact current	30 mA			
Reference standards	EN 1760-2:2001+A1:2009, EN ISO 13849-1			
Safety parameters	Combined with GP02/E	Combined with GP02R.T		
Category	3	3		
PL	e	e		
PFH	$8,58 \cdot 10^{-8}$	$8,58 \cdot 10^{-8}$		
No. of operations/year	5000	5000		
Usage categories	DC13(24) – 1,5A AC1(230) – 1,5A AC15(230) – 2A	AC15(230) – 1,2 A		
Mission time [years]	20	20		
Max controllable length	12 m	20 m		
Part of human body which can be detected	Hand, limb, body			

How to order a sensitive edge type B0-B1N-B2-B2N:

Example: ordering a sensitive edge, length 1 m.

For a correct order, always specify:

- type of sensitive edge... (ex. **B1N**)
- length (mm) of the profile... (ex. 1000 mm)
- length of the supply cable and outlet (ex. CS standard 3 m with head outlet.

Specify if different for type B1N-B2-B2N.only.

- the fastening profile (ex."SAC25" or "SAI25" or "SAL25" see drawing)

The complete description for the order is:

Sensitive edge type B1N L=1000 mm-CS-SAC

The conductive edges 8,2k Ω

Featuring a thermoplastic profile TPV with 2 co-extruded parts of conductive material (sensor) and 2 copper wires, to stabilize the resistive value of the contact on the length of the edge.

Particularly suitable for external use, with any environment and temperature (-15°C +55°C).

It can be supplied as a **“do it yourself” solution**, with a series of accessories allowing to the customer/installer to implement the edge directly on the machine.

Upon request, the edge can be tailor-cut and supplied complete with all accessories.

The supply of the system is made by electric cable 2 wires 2*0,35 mm² CEI 20-22 with die-cast

needle connector to allow an easy insertion into the chamber containing the copper cable. Standard length of cable 3 meters.

The electric circuit is closed by a needle connector containing an electric resistance 8,2kOhm.

The ends of the edge are sealed by means of special plugs that, stuck with a special stick, have a better tightness to water.

The standard outlet of the supply cable is at the end of the profile. If the outlet is lateral or on the bottom, please communicate at the order. For the “do it yourself” solution, the cable outlet is made by drilling the cable hole into the terminal plug.

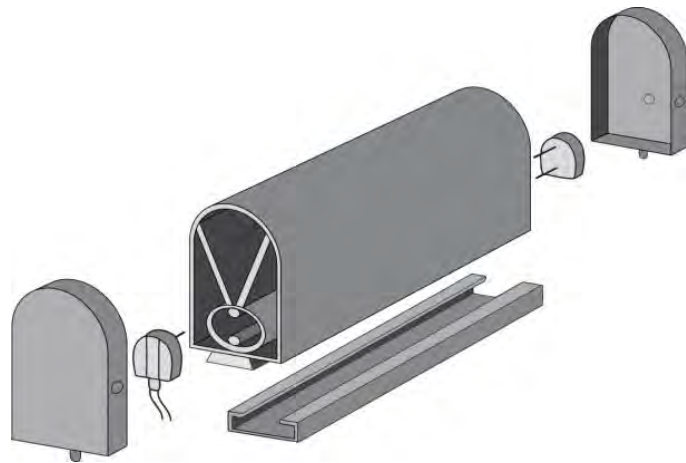

Type Available:

<p>Type B1NC</p>	<p>Type B1NC-AG Universal foot</p>	<p>Type B1NC-AGB Universal foot with lips</p>
<p>Type B2C</p>	<p>Type B2C-AG Universal foot</p>	<p>Type B2C-AGB Universal foot with lips</p>
<p>Type B0C</p>	<p>Type B0C-AG Universal foot</p>	<p>Pack in roll</p>

TECHNICAL FEATURES

Description	Type B1NC	Type B1NC-AG	Type B2C
	Type B1NC-B	Type B1NC-AGB	
Max operating angle α	90°		
Pre-run (specimen $\varnothing 80$ - 100 mm/sec)	5,05 mm		5,40
Overrun (specimen $\varnothing 80$, 10 mm/sec)	15,639 mm - 250N 17,939 mm - 400N 20,237 mm - 600 N		3,28 mm - 250N 4,18 mm - 400N 6,88 mm - 600N
Max operating force (specimen $\varnothing 80$ - 100 mm/sec)	146 N (-15°C)		84 N (-15°C)
Material	TPE black colour		
Length*	Mounted version, max 6 mt or 25 m-long roller		
Max length of sensor	20 m (can be controlled via control unit)		
Weight kg/m	0,6		0,4
Mounting orientation	All		
Fastening material	aluminium profile standard Length = 6 m		
Dimensions of non-sensitive surface	40 mm from each end		
Operating temperature	-15° +55°C		
Chemical resistance	See Table		
Max applicable thrust	500 N		
Degree of protection (EN 60529)	IP65		IP67
Storage temperature	-15 °C - 55° C		
Power cord*	2*0.35 mm ²		
Output contact	N.O		
Max. length of connection CABLES	100 m.		
Rated supply voltage	24 VDC		
Max contact voltage	30 V		
Max contact current	30 mA		
Reference standards	EN 1760-2 : 2001+ A1:2009, EN ISO 13849-1; EN ISO 12978		
Safety parameters	Combined with GP02R		Combined with GP02R-C
Category	3		
PL	e		
PFH	8,58*10 ⁻⁸		
No. of operations/year	5000		
Usage categories	AC15(230) – 4 A		AC15(230)/DC13(24) – 3 A
EC-TYPE certification	10DM4SA107		10DM4SA107
Mission time [years]	20		
Part of human body which can be detected***	Hand, limb, body		

How to order a sensitive edge type B1NC

Always specify the following:

- Type of sensitive edge... (ex. **B1NC**)
- Length (mm) of the profile.. (ex. 1000 mm)
- Length of the supply cable and outlet ... (ex. CS standard 3 m, head outlet. If different, specify the length and the outlet.
- Type of fastening support (ex. "SAC29" or "Sal29" or "SAL29")

The complete order is therefore:

Sensitive edge type B1NC L=1000 mm-CS-SAC

For the " Do it yourself " solution, order according to the following details:

- n. 1 package profile type **B1NC** (roll 25 m)
- n. 1 package connector kits type **KC** (n. 1 connector with resistance type KCR + n. 1 connector with electric cable type KCC)
- n. 1 package standard length 6 m support of aluminium type **SAC29 - SAL29 - SAI29** for profile fastening
- n. 1 Kit package with 2 closing plugs type: **TC1** for profile B1NC,
- n. 1 bottle 10 ml of primer cod. **PR**
- n. 1 bottle 10 ml of glue cod. **CY**

How to order a sensitive edge type B1NC-AG, B1NC-AGB (universal foot)

The edge B1NC-AG is different than the B1C type only for the anchorage foot studied for replacing in total the other product present into the market and for its accessories.



For ordering this type specify the following:

- Type of sensitive edge... (ex. **B1NC-AG**)
- Length (mm) of the profile.. (ex. 1000 mm)
- Length of the supply cable..(CS standard 3 m), *The outlet cable can be only bottom side.*



For the " Do it yourself " solution, order according to the following details:

- n. 1 package profile type **B1NC-AG** (roll 25 m)
- n. 1 package connector kits type **KC1AG** (n. 1 closing/connector with resistance type KC1AGR + n. 1 closing/connector with electric cable type KC1AGC)
- n. 1 bottle 10ml of primer cod. **PR**
- n. 1 bottle 10ml of glue cod. **CY**

Single items to order B1NC in case of " Do it yourself " solution

Single connector with cable (B1NC) type KCC code GSB1NCKCC	
Single connector with resistance (B1NC) type KCR code GSB1NCKCR	
Closing stopper (B1NC) type TC1 cod. GSB1NCTC1 (pack 2 pcs.)	

Single items to order B1NC-AG, B1NC-AGB in case of " Do it yourself " solution

Closing connector with cable (B1NC-AG or B1NC-AGB) type KC1AGC code GSB1NCAGKC1AGC	
Closing connector with resistance (B1NC-AG or B1NC-AGB) type KC1AGR code GSB1NCAGKC1AGR	

How to order a sensitive edge type B2C or B2AC-AG

Always specify the following:



- Type of sensitive edge... (ex. **B2C**)
- Length (mm) of the profile.. (ex. 1000 mm)
- Length of the supply cable (CS standard 3 m)

The outlet cable can be only bottom side.

Type of fastening aluminium support (see page 15)
The complete order is following:

Sensitive edge type B2C L=1000 mm-CS-SAC

Single items to order B2C in case of “ Do it yourself “ solution

Closing connector with cable (B2C, B2C-AG, B2C-AGB,) type KC2C code GSB2CKC2C	
Closing connector with resistance 8.2 kohm (B2C, B2C-AG, B2C-AGB) type KC2R code GSB2CKC2R	

For the “ Do it yourself ” solution, order according to the following details:

- n. 1 package profile type **B2C** (standard roll 25 m)
- n. 1 package connector type **KC2** (n. 1 closing/connector with resistance type KC2R + n. 1 closing/connector with electric cable type KC2C)

Type of fastening aluminium support (see page 15)

- n. 1 bottle 10 ml of primer cod. **PR**
- n. 1 bottle 10 ml of glue cod. **CY**

How to order a sensitive edge type B0C

Always specify the following:

- Type of sensitive edge... (ex. **B0C**)
- Length (mm) of the profile.. (ex. 1000 mm)
- Length of the supply cable (CS standard 3 m)





The outlet cable can be only STANDARD.

Sensitive edge type B0C L=1000 mm-CS

For the “ Do it yourself ” solution, order according to the following details:

- n. 1 package profile type **B0C** (standard roll 50 m)
- n. 1 package connector type **KC0** (n. 1 closing/connector with resistance type B0CKCR + n. 1 closing/connector with electric cable type B0CKCC)

- n. 1 bottle 10 ml of primer cod. **PR**
- n. 1 bottle 10 ml of glue cod. **CY**

Closing connector with cable (B0C, B0C-AG) type B0CKCC code GSB0CKCC	
Closing connector with resistance 8.2 kohm (B0C, B0C-AG) type B0CKCR code GSB0CKCR	
Flacone colla 10 ml tipo CY cod. GSBCY	
Flacone Primer 10 ml tipo PR cod. GSBPR	

EDGE FASTENING

The edge fastening is made assembling the profile on the aluminium support, to be specified in the order.

Types of aluminium supports available:

- support " C " fastening cod. SAC
- support " L " fastening cod. SAL
- support " I " fastening cod. SAI

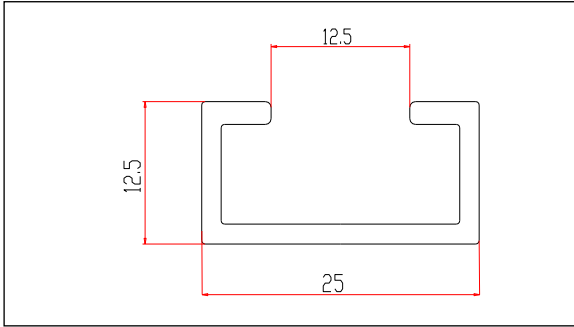

Support fastening type **SAC 25**
Suitable for edges type B1N, B2, B2N, B1NC-AG, B2C-AG

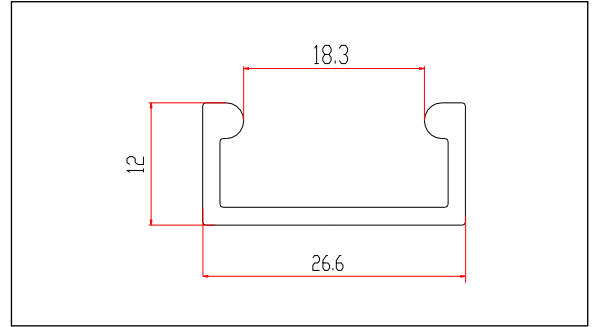

Support fastening type **SAC 29**
Suitable for edges type B1NC, B2C

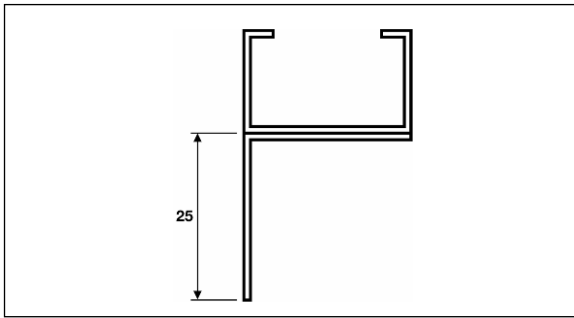

Support fastening " L " type **SAL**

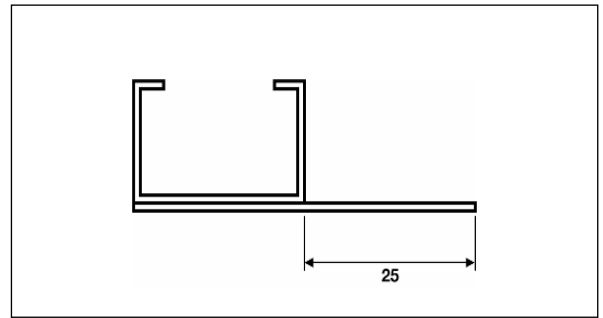

Support fastening " I " type **SAI**

All edges listed in this documentation can be supplied in bent version, with the following radiuses:

-Edge type B1N

Picture A: minimum bending radius 800 mm

Picture B: Not recommended

-Edge type B2, B2N

Pictures A + B: Not recommended

-Edge type B1NC, B1NC-AG, B2C, B2C-AG

Picture A: minimum bending radius 500 mm

Picture B: minimum bending radius 500 mm

-Edge type B0C, B0C-AG

Pictures A + B: Not recommended

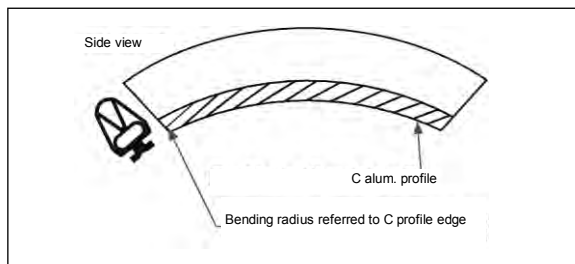

Picture A: minimum bending radius

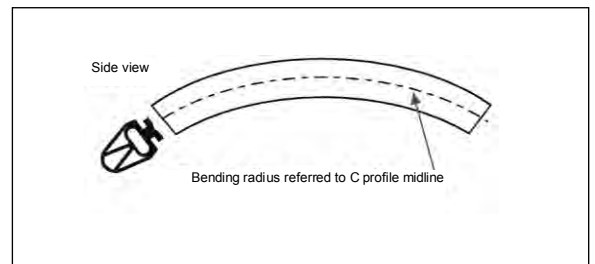

Picture B: minimum bending radius

Series connection of two or more sensitive resistive edges 8.2 kohm

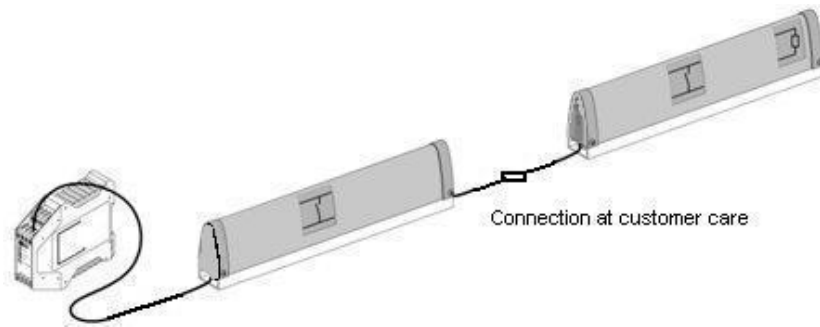

For applications with two or more resistive sensor in " series ", for a proper connection must be provided the first sensor with input-output cable and the last of the series with the input cable and resistor (see above picture).

In case of solution " Do it yourself " for the series connection between more resistive edges following the accessories here after write:

Example of order for connecting of two sensor:

- For type **B1NC**:

N.03 Needle connector with cable (B1NC) type KCC code GSB1NCKCC

N.01 Needle connector with resistance (B1NC) type KCR code GSB1NCKCR

N.02 Closing plug (B1NC) type TC1 cod. GSB1NCTC1

- For type **B2C**

N.03 Needle plug with cable (B2C) type KC2C code GSB2CKC2C

N.01 Needle plug with resistance (B2C) type KC2R code GSB2CKC2R

- For type **B0C**

N.03 Needle plug with cable type B0CKCC code GSB0CKCC

N.01 Needle plug with resistance type B0CKCR code GSB0CKCR

CONTROL UNIT/DEVICE TO CONTROL MATS EDGES AND SHOCK ABSORBERS

The control unit is a device to control the function of a sensor (mat, edge or shock absorber) by blade contacts.

The blade contact is a NO contact that closes, causing the opening of the outlet contact of the control unit.

The control unit controls the operation of the sensor and the connection circuit, and allows to

transform the NO signal of the blade contact into a NC safety signal.

A control device can control several sensors, but cannot perform the auto-diagnose indicating which sensor is faulty. If more sensors are used, use a control unit every 3-4 sensors.

MODELS AVAILABLE:

GP02/E

GP02R.T – GP02R.T1

GP02R and GP02R-C Only for edges with electrical resistance 8,2kΩ

CONTROL UNIT

Description

Emergency stop circuit, used to manage and control a sensor, having two safety relays terminals with forced opening contacts.

The two relays, normally excited, are deenergized in the following conditions:

- No supply
- Operation of mat, edge, shock absorber.
- Internal faults
- Interruption of the internal circuit of mat, edge, shock absorber or connection cables between control unit and sensor (mat, edge, shock absorber).

The devices are supplied with **automatic reset** but they can be transformed into **manual reset**.

If a control unit is used **without rearming** the function must be supplied by the control system of the machine (see std. EN 13849-1).

Operation

Two separate channels detect the voltage at the end of the safety terminals of the mat, and each channel commutes a safety relay with forced opening contacts.

Models GP02/E- GP02R.T(automatic restart)- GP02R.T1(manual restart)

The supply voltage is limited by a specific group and the pilot circuit, to avoid short circuit currents while closing the sensor (mat, edge, shock absorber). The control unit controls itself, as well as any other operation.

Inlet terminals are foreseen for:





- Test signal activating/deactivating the circuit of the control device simulating the operation of the sensor and checking the system efficiency.
- Signal of manual reset/ feedback-action.

The two modules are differentiated by the number of outlet contacts: model GP02/E has a NO safety contact, whereas model GP02/E-S2 and GP02R.T has two NO safety contacts.

Model GP02R and GP02R-C only for edges with electrical resistance 8,2kΩ

Two symmetric circuits detect the current in the edge, adjusted for a resistance of 8,2 kΩ. When the circuits detect a variation of ± 4 kΩ, caused by a fault or operation of the edge, they desexcite the outlet relays, that open the safety contacts.

TECHNICAL FEATURES

	TYPE GP02/E	TYPE GP02R.T	TYPE GP02R 8,2k Ω	TYPE GP02R-C 8,2k Ω
Reference Standards: EN ISO13849-1, EN1760-EN60947-5-1 EN 50205 (type A)				
PL	e			
Category	3			
PFH (1/h)	4,29*10 ⁻⁸			
No. of operations/year	35000	50000	5000	5000
Usage categories	DC13(24) – 1,5 A AC1(230) – 3A	AC15(230) – 1,2 A	AC15(230) -4 A	AC15(230) – 3A DC13(24) – 3A
Mission time [years]	20			
Electrical data				
Supply voltage	24 VDC \pm 10%			
Current consumption with mat activated (24VDC)	15 mA			
Current consumption with reset module 24VDC)	90 mA			
Internal protection of power supply	YES (1 A)			
Inputs				
Input short-circuit detection	YES			
Input connection interruption detection	YES			
Max length of connection cables	100 m			
Min section of connection cables	0,35 mm ² (1mm ² L>20m)			
Max resistance of sensor	100 ohm	40 ohm		
Voltage applied to inputs	24 VDC			
Max current (peak value)	200 mA			
Safety outputs				
Number of safety outputs	1 NO	2 NO		
Rated voltage/Max switchable voltage VAC	250/400	230/300		
Rated current	6 A	AC15 230 VAC 1,5A DC13 24VDC 1,2 A		
Material of standard contacts	AgNi	AgSnO ₂		
Rated supply voltage	V AC50/60hz	-		
	V DC	24		
Rated power AC/DC VA (50 Hz)/W	-/0,7	-/0,25		
Delay to energizing (reset)	25 ms (typical)	12 ms		
Delay to de-energizing (trip)	10 ms (typical)	13 ms		
Protection against over-current	4 A quick-action/2 A delayed			
Mechanical life	10 ⁹	10 ⁷		
Signal outputs				
Number of signal outputs	1			
Max operating voltage	VAC	125		
	VDC	30		
Max current 110VAC	0,2A			
Max current 24VDC	0,5A			
Environmental characteristics				
Operating temperature [°C]	0 / 55	-25 /+50		
Storage temperature [°C]	-20 /+70	-25 /+70		
Max relative humidity	85%			
Degree of protection of terminals	IP20			
Degree of protection of casing	IP30			IP65
Dimensions				
Width [mm]	35	22,5	120	
Height [mm]	90	114	75	
Depth [mm]	70	99	155	
Weight [g]	150	140	410	
Material of the casing	ABS	PA66-FR	GW PLAST 75	
Installation	ON 35 mm Omega rail			
EC-TYPE CERTIFICATION	RP10DM4SA113	RP11DM4SC12	RP10M4SA107	

CONTROL UNIT WIRELESS SYSTEM (RADIOSAFE) FOR CONDUCTIVE EDGE 8,2 KΩ

IN ACCORDANCE TO THE SAFETY STANDARD EN12978

“TRANSCEIVER” INTERFACE FOR SAFETY EDGES

SAFEPRC4 – 433 MHz “FM”

SAFEPRC8 – 868 MHz “FM”

SAFETY EDGE SIGNAL INPUT NC/8.2kΩ



STATIONARY WIRELESS “TRANSCEIVER” SAFETY SYSTEM

SAFEDECX4 – 433 MHz “FM”

SAFEDECX8 – 868 MHz “FM”

SAFETY DEVICES 8

SAFETY OUTPUTS 3 NC/8.2KΩ

MAXIMUM RANGE 30 m

PROTECTION GRADE IP65

OPERATING TEMPERATURE – 20...+55°C



Radiosafe is made up of high technology appliances, protected by robust and practical enclosure with an elevated degree of protection against environment condition.

The transmission via radio between the “transceiver” interface (safety edge interface) and the stationary “transceiver” eliminates the need for one or more safety edges to be connected to the control unit by wires. This allows a more manageable and secure application of the safety edge directly onto the gate in movement.

Radiosafe is a highly professional safety device that in combination with Gamma System’s safety edges it is conform to the European safety standard EN12978.

The stationary “transceiver” is able to manage up to 8 security device via radio and is fitted with 3 safety outputs NC/8.2kΩ settable by jumpers. The semi-transparent cover allows to verify the status of the safety device and the level of batteries charge visualized by LEDs.

Each radio controlled safety device can be associated with one of the three safety outputs by a dip-switch.

The 3V Lithium battery is reliable under all weather conditions and furnishes a high level of safety and top performance in all environments.

Note: The choice of operating frequency for the safety edge should be made after taking into consideration the operating frequency of the other units in the installation.

E.g. If the command units are working at a frequency of 433 MHz it is good practice to use a safety radio on the edge that works at a frequency of 868 MHz and vice-versa.

10044 Pianezza – TO – Via Torino, 24/I – ITALY
Tel. +39 011 968 24 66 r.a. – Fax +39 011 967 42 11
e-mail: info@gammasystem.com
www.gammasystem.com

